

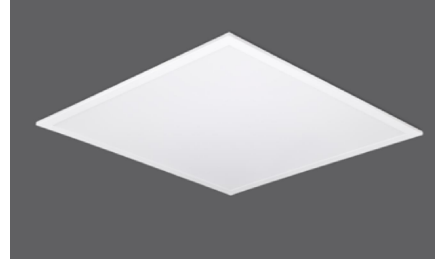

Flat-G 600

Sıva Altı / Recessed

02110

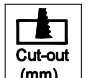

IP 40	IK 02	220-240V 50/60Hz		Ra≥80					Ta=25°C	
----------	----------	---------------------	---	-------	---	---	--	---	---------	---

Ürün Kodu Product Code	Güç Power (W)	W (mm)	L (mm)	H (mm)	 Cut-out (mm)	Işık Akısı Light Flux (lm)	Renk Sıcaklığı Color Temperature (K)	 max min	 kg
02110.66.30.031/40.032	28	595	595	60	575 x 575	3450	3000	-20C°/+40C°	2.8
02110.66.30.036/40.037	33	595	595	60	575 x 575	3600	4000	-20C°/+40C°	2.8
02110.66.30.040/40.041	35	595	595	60	575 x 575	3450	3000	-20C°/+40C°	2.8
02110.66.30.029/40.030	29	595	595	60	575 x 575	3600	4000	-20C°/+40C°	2.8

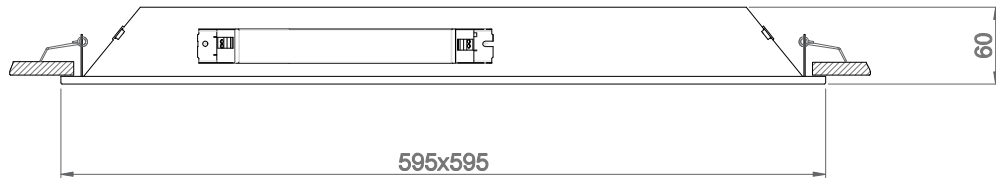
 UYARI

- Bakım ve montaj yalnızca kalifiye personel tarafından yapılmalıdır.
- Servis yapmadan önce bağlantıyı kesin.
- Armatür, alçak gerilim beslemesi ile kontrol iletkenleri arasında temel izolasyona sahiptir.
- Armatür termal yalıtım malzemesi ile kaplanmaya uygun değildir.
- Bina içi ve bina dışı kullanıma uygundur.
- Armatürler iletken yüzeylere montaj yapılamaz.
- Onarım ve bakım sırasında yalnızca orjinal parçalar kullanılmalıdır.
- Eğer armatürde sonradan değişiklik yapılırsa, değişiklikten sorumlu, üretici olarak kabul edilecektir.
- Üretici uygunsuz kullanım ya da uygulama sebebiyle meydana gelen hasar konusundan sorumluluk kabul etmez.

- Lütfen elektrikli ve elektronik ürünler için yerel atık imha, ayırma ve toplama sistemi hakkında bilgi edinin. Lütfen yerel kurallarınıza göre hareket edin ve eski ürününüzü normal ev atığınızla birlikte atmayın. Ürününüzün doğru şekilde imha edilmesi, çevre ve insan sağlığı için olası olumsuz sonuçları önlemeye yardımcı olacaktır.

 WARNING

- Installation / maintenance only by skilled personnel.
- Disconnect before servicing.
- Luminaire has basic insulation between low voltage supply and control conductors.
- Luminaire is not suitable for covering with thermal insulation material.
- Suitable for indoor and outdoor use.
- The luminaires are not allowed to be mounted on conductive surface.
- During overhaul / maintenance only use original parts.
- If any luminaire is subsequently modified, the person, responsible for the modification shall be considered the manufacturer.
- The manufacturer bears no liability for damage caused by inappropriate use or application.

- Please inform yourself about the local waste disposal, separation and collection system for electrical and electronic products. Please act according to your local rules and do not dispose of your old product with your normal household waste. The correct disposal of our product will help prevent potential negative consequences for the environment and human health.

1.

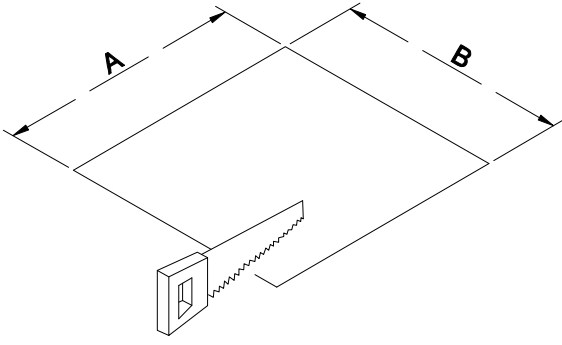

2.

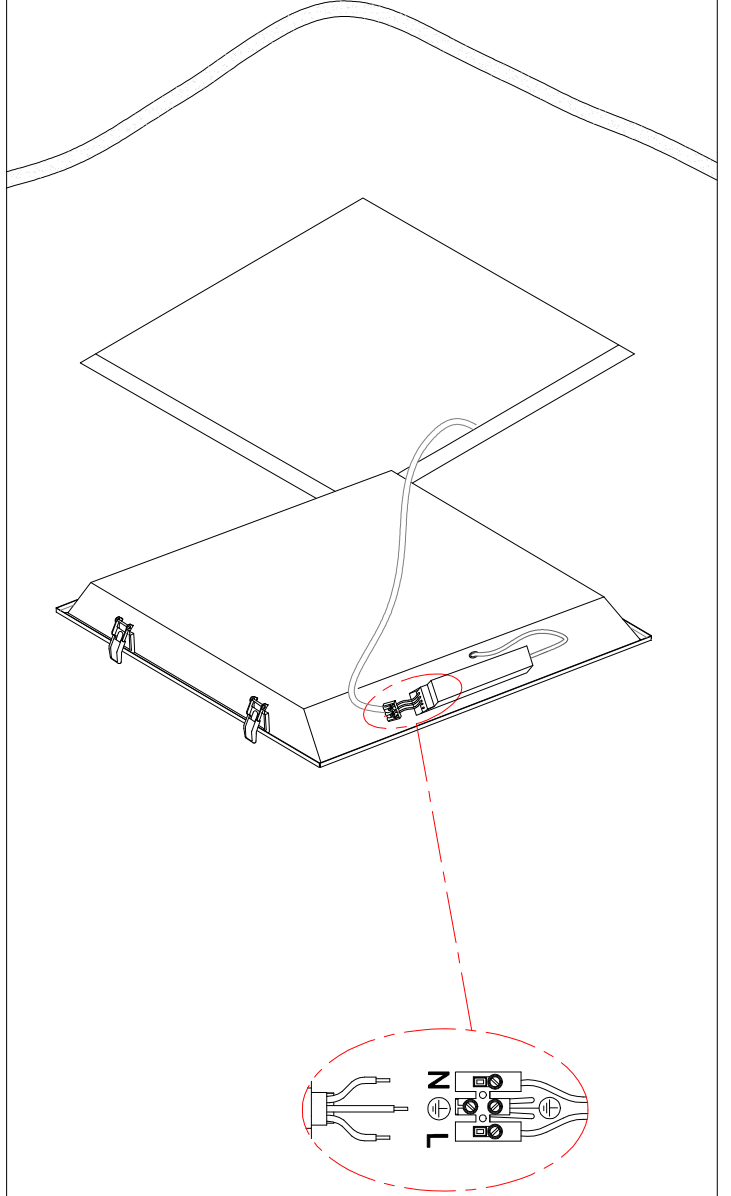

(TR) Bu armatürde bulunan ışık kaynağı ve / veya kontrol tertibatı ve / veya harici esnek kablo, yalnızca imalatçı veya onun servis temsilcisi veya benzer bir kalifiye kişi tarafından değiştirilmelidir.

(ENG) The light source and/or control gear and/or the external flexible cable contained in this luminaire shall only be replaced by the manufacturer or his service agent or a similar qualified person.

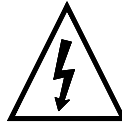

3a.

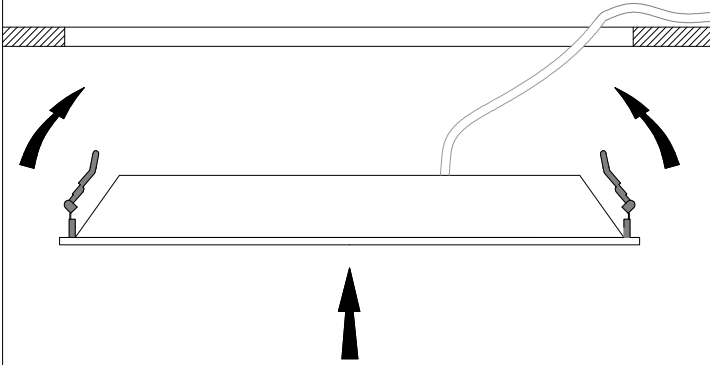

3b.

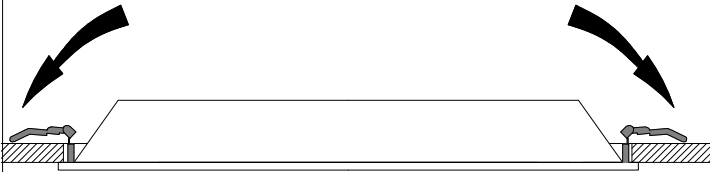

5.

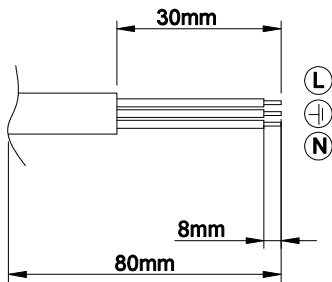

Ø 5-10 mm
Min.3x0.75-1.5mm² TTR
H05RN-F

DALI system

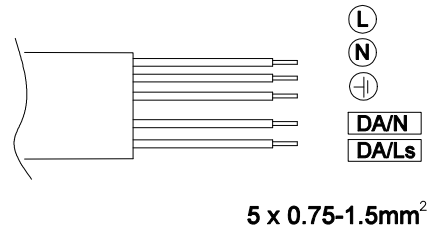

(TR) Armatürün harici bükülgen kablo veya kordonun hasar görmesi durumunda ; bir tehlike meydana gelmesini engellemek için yalnızca imalatçı veya onun yetkili servisi ya da eşdeğer nitelikli kalifiye personel tarafından değiştirilmesi gerekir.

(ENG) If the external flexible cable or cord of this luminaire is damaged, it shall be exclusively replaced by the manufacturer or his service agent or a similar qualified person in order to avoid a hazard.

(TR) Verilen bilgiler önceden bildirilmeksizin değiştirilebilir. Laboratuvar koşullarında ölçülen tüm değerler tasarım veya tipik değerlerdir, ikizler aydınlatma bu performansın son kullanım koşullarında elde edileceğini garanti vermez.

(ENG) Information provided is subject to change without notice. All values are design or typical values when measured under laboratory conditions and ikizler lighting makes no warranty or guarantee, express or implied, that such performance will be obtained under end-use conditions.