

Canvas

İç Aydınlatma - Downlight Aydınlatma

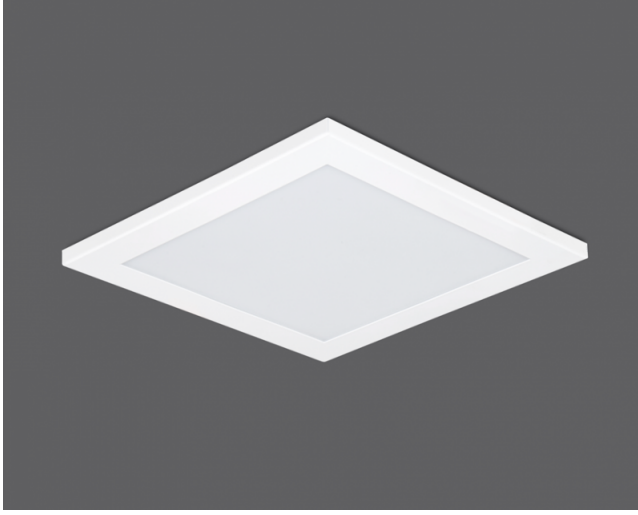

Renk Seçenekleri



TEKNİK BİLGİLER

Gövde	Metal Sac
Çerçeve	Metal Sac
Difüzör	Yüksek Işık Geçirgenlikli Opal
Boya	Elektrostatik Toz Boya

OPTİK ÖZELLİKLER

Optik	Simetrik
Işık Çıkış Açısı	110°
UGR Derecesi	UGR ≤ 22
CRI	CRI ≥ 80
Renk Bin Değeri	Mc Adams ≤ 3

ELEKTRİKSEL

Güç (W)	13-18W
Güç Faktörü	>0.95
Işık Kaynağı	SMD Mid Power LED
Kablo	Halojen-Free
Giriş Voltajı	220-240V AC / 50-60 Hz
LED Sürücü	Yüksek Verimli Sabit Akım Çıkışı
Ortam Sıcaklığı	-20°C / +50°C
LED Ömür L80B50	>50.000 Saat

OPSİYONEL

- DALI	- 1-10V DIM
- Tunable White	- Acil Aydınlatma Ünitesi
- Mikroprizmatik Difüzör (UGR < 19)	- CRI > 90
- 2700K ~ 6500K	- Farklı RAL Renk Seçenekleri
- Plug-in Connector	- Class-I Koruma Sınıfı
- PIR Sensör	- AC-DC Besleme(MBS)

MONTAJ

Montaj Tipi	Sıva Altı
Montaj Aparatı	Çelik Yay

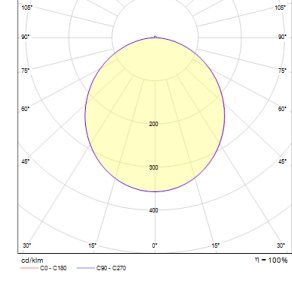
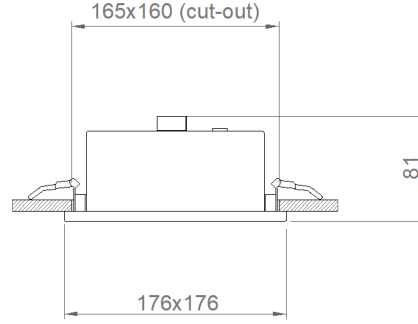

Sipariş Kodu	W	Lm	CCT	CRI	WxLxH (mm)	Tavan Kesim Ölç (mm)	Kg
05247.22.40.022	18	1920	4000	Ra>80	175x175x81	165x160	0,6

