

Snow-023 IP65

İç Aydınlatma - Downlight Aydınlatma



Renk Seçenekleri



Ral 9016

Ral 9006

Ral 9005

TEKNİK BİLGİLER

Gövde	Alüminyum Enjeksiyon
Difüzör	Opal Difüzör + Temperli Şeffaf Cam
Çerçeve	Alüminyum Enjeksiyon
Boya	Elektrostatik Toz Boya
Conta	Şeffaf Silikon

OPTİK ÖZELLİKLER

Optik	Simetrik
Işık Çıkış Açısı	110°
UGR Derecesi	UGR ≤ 22
CRI	CRI ≥ 80
Renk Bin Değeri	Mc Adams ≤ 3

ELEKTRİKSEL

Güç (W)	26-30W
Güç Faktörü	>0.95
Işık Kaynağı	SMD Mid Power LED
Kablo	Halojen-Free
Giriş Voltajı	220-240V AC / 50-60 Hz
LED Sürücü	Yüksek Verimli Sabit Akım Çıkışlı
Ortam Sıcaklığı	-20°C / +50°C
LED Ömür L80B50	>50.000 Saat

OPSİYONEL

- DALI	- 1-10V DIM
- Tunable White	- Acil Aydınlatma Ünitesi
- Mikroprizmatik Difüzör (UGR < 19)	- CRI > 90
- 2700K ~ 6500K	- Farklı RAL Renk Seçenekleri
- Plug-in Enerji Giriş Konnektörü	- Class-I Koruma Sınıfı
- PIR Sensör	- AC-DC Besleme(MBS)
- IP 65 Sürücü Kutusu	

MONTAJ

Montaj Tipi	Sıva Altı
Montaj Aparatı	Çelik Yay

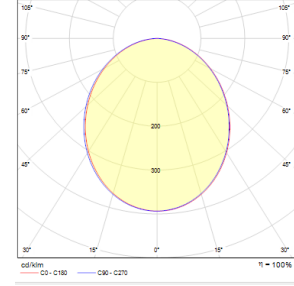
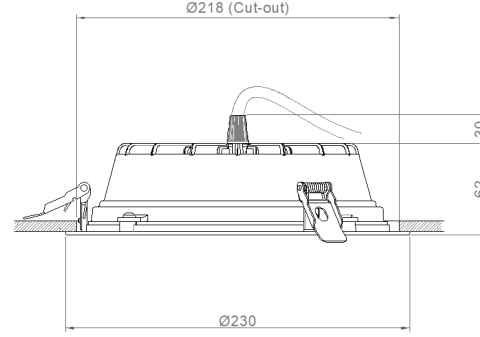

Sipariş Kodu	W	Lm	CCT	CRI	Tavan Kesim Ölç (mm)	Kg
05393.23.30.026	30	2450	3000	Ra>80	Ø218	0,90

