

# Star

İç Aydınlatma - Spot Aydınlatma



Renk Seçenekleri



## TEKNİK BİLGİLER

<b>Gövde</b>	Ekstrüzyon Alüminyum
<b>Çerçeve</b>	Alüminyum Enjeksiyon
<b>Reflektör</b>	Metalize Yüzeyli Optik
<b>Boya</b>	Elektrostatik Toz Boya

## OPTİK ÖZELLİKLER

<b>Optik</b>	Simetrik
<b>Işık Çıkış Açısı</b>	13°, 24°, 40°, 60°
<b>UGR Derecesi</b>	UGR < 25
<b>CRI</b>	CRI ≥ 80
<b>Renk Bin Değeri</b>	Mc Adams ≤ 3

## ELEKTRİKSEL

<b>Güç (W)</b>	11-36W
<b>Güç Faktörü</b>	>0.95
<b>Işık Kaynağı</b>	COB LED
<b>Kablo</b>	Halojen-Free
<b>Giriş Voltajı</b>	220-240V AC / 50-60 Hz
<b>LED Sürücü</b>	Yüksek Verimli Sabit Akım Çıkışı
<b>Ortam Sıcaklığı</b>	-20°C / +50°C
<b>LED Ömür L80B50</b>	>50.000 Saat

## OPSİYONEL

- DALI	- 1-10V DIM
- Tunable White	- Acil Aydınlatma Ünitesi
- CRI > 90	- 2700K ~ 6500K
- Farklı RAL Renk Seçenekleri	- Plug-in Enerji Giriş Konnektörü
- Class-I Koruma Sınıfı	- AC-DC Besleme(MBS)

## MONTAJ

<b>Montaj Tipi</b>	Sıva Altı
<b>Montaj Aparatı</b>	Çelik Yay

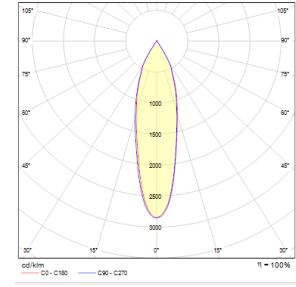
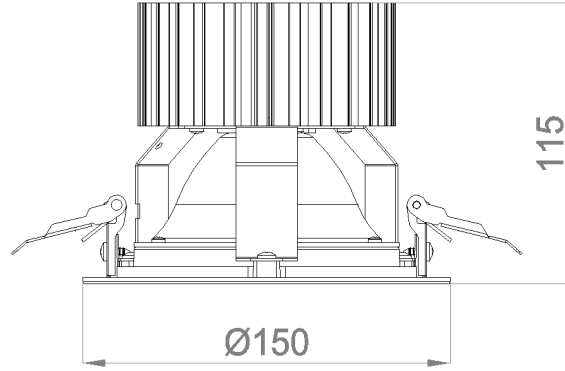

Sipariş Kodu	W	Lm	CCT	CRI	Kesim Ölç. (mm)	Kg
05110.15.40.037	30	3700	4000	Ra>80	Ø138	0,7

