

Star

İç Aydınlatma - Spot Aydınlatma



Renk Seçenekleri



TEKNİK BİLGİLER

Gövde	Ekstrüzyon Alüminyum
Çerçeve	Alüminyum Enjeksiyon
Reflektör	Metalize Yüzeyli Optik
Boya	Elektrostatik Toz Boya

OPTİK ÖZELLİKLER

Optik	Simetrik
Işık Çıkış Açısı	13°, 24°, 40°, 60°
UGR Derecesi	UGR < 25
CRI	CRI ≥ 80
Renk Bin Değeri	Mc Adams ≤ 3

ELEKTRİKSEL

Güç (W)	11-36W
Güç Faktörü	>0.95
Işık Kaynağı	COB LED
Kablo	Halojen-Free
Giriş Voltajı	220-240V AC / 50-60 Hz
LED Sürücü	Yüksek Verimli Sabit Akım Çıkışı
Ortam Sıcaklığı	-20°C / +50°C
LED Ömür L80B50	>50.000 Saat

OPSİYONEL

- DALI	- 1-10V DIM
- Tunable White	- Acil Aydınlatma Ünitesi
- CRI > 90	- 2700K ~ 6500K
- Farklı RAL Renk Seçenekleri	- Plug-in Enerji Giriş Konnektörü
- Class-I Koruma Sınıfı	- AC-DC Besleme(MBS)

MONTAJ

Montaj Tipi	Sıva Altı
Montaj Aparatı	Çelik Yay

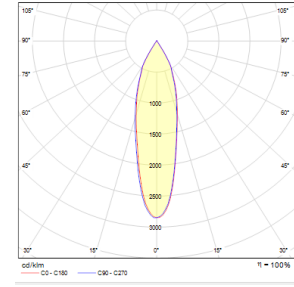
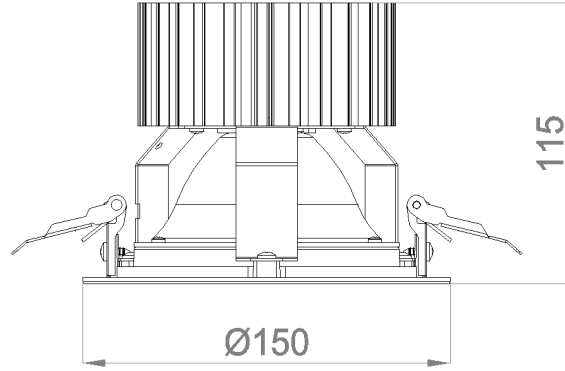

Sipariş Kodu	W	Lm	CCT	CRI	Kesim Ölç. (mm)	Kg
05110.15.40.025	18	2500	4000	Ra>80	Ø138	0,7

