

Yuwi

İç Aydınlatma - Spot Aydınlatma



Renk Seçenekleri



TEKNİK BİLGİLER

Gövde	Alüminyum Ekstrüzyon Profil
Yan Kapak	Alüminyum Enjeksiyon
Difüzör	PC Optik Lens + Metal Işık Kırıcı
Boya	Elektrostatik Toz Boya

OPTİK ÖZELLİKLER

Optik	Simetrik / Asimetrik
Işık Çıkış Açısı	60° / 90° / 25°
UGR Derecesi	UGR ≤ 22
CRI	CRI ≥ 80
Renk Bin Değeri	Mc Adams ≤ 3

ELEKTRİKSEL

Güç (W)	28-49W
Güç Faktörü	>0.95
Işık Kaynağı	Mid Power LED
Kablo	Halojen-Free
Giriş Voltajı	220-240V AC / 50-60 Hz
LED Sürücü	Yüksek Verimli Sabit Akım Çıkışı
Ortam Sıcaklığı	-20°C / +50°C
LED Ömür L80B50	>50.000 Saat

OPSİYONEL

- DALI	- 1-10V DIM
- Tunable White	- CRI > 90
- 2700K ~ 6500K	- Farklı RAL Renk Seçenekleri
- AC-DC Besleme(MBS)	

MONTAJ

Montaj Tipi	Ray Soket
--------------------	-----------

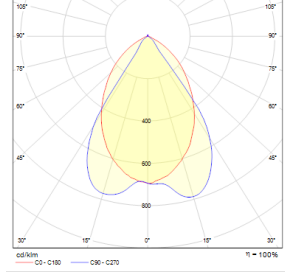
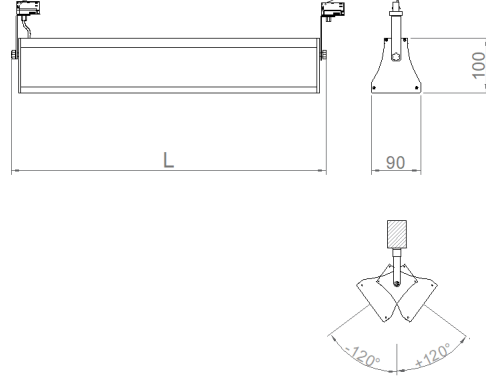

Sipariş Kodu	W	Lm	CCT	CRI	WxLxH (mm)	Kg
01196.91.30.046	42	4656	3000	Ra>80	900x90x100	3,1

