

Getto

İç Aydınlatma - Endüstriyel Aydınlatma



Renk Seçenekleri



Ral 7016

TEKNİK BİLGİLER

Gövde Alüminyum Enjeksiyon
Reflektör Şeffaf Optik Lens
Boya Elektrostatik Toz Boya

OPTİK ÖZELLİKLER

Optik Simetrik
Işık Çıkış Açısı 60°, -90°, -120°
UGR Derecesi UGR ≤ 22
CRI CRI ≥ 80
Renk Bin Değeri Mc Adams ≤ 3

ELEKTRİKSEL

Güç (W) 60-160W
Güç Faktörü >0.95
Işık Kaynağı SMD Mid Power LED
Kablo Halojen-Free
Giriş Voltajı 220-240V AC / 50-60 Hz
LED Sürücü Yüksek Verimli Sabit Akım Çıkışlı
Ortam Sıcaklığı -20°C / +50°C
LED Ömür L80B50 >50.000 Saat

OPSİYONEL

- DALI
- Acil Aydınlatma Ünitesi
- 2700K ~ 6500K
- Plug-in Connector
- PIR Sensör
- 1-10V DIM
- CRI > 90
- Farklı RAL Renk Seçenekleri
- Class-I Koruma Sınıfı
- AC-DC Besleme(MBS)

MONTAJ

Montaj Tipi Sıva Üstü
Montaj Aparatı Metal Braket

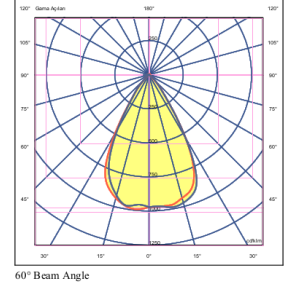
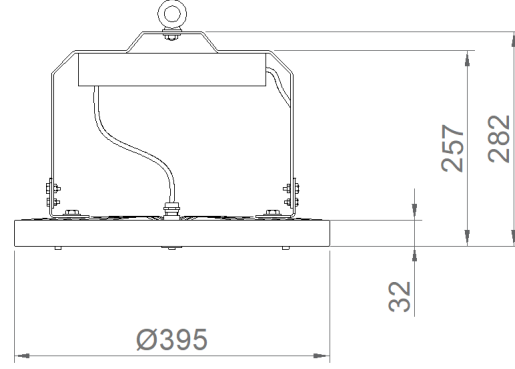

Sipariş Kodu	W	Lm	Lm	CRI	Kg
07306.39.40.080	60	8340	4000	Ra>80	4,2

