

# Angel 1200

İç Aydınlatma - Sarkıt Aydınlatma



Renk Seçenekleri



Ral 9016

Ral 9006

Ral 9005

## TEKNİK BİLGİLER

**Gövde** Ekstrüzyon Alüminyum Profil  
**Difüzör** Yüksek Geçirgenlikli Opal Difüzör  
**Boya** Elektrostatik Toz Boya

## OPTİK ÖZELLİKLER

**Optik** Simetrik  
**Işık Çıkış Açısı** 120°  
**UGR Derecesi** UGR ≤ 22  
**CRI** CRI ≥ 80  
**Renk Bin Değeri** Mc Adams ≤ 3

## ELEKTRİKSEL

**Güç (W)** 60-120W  
**Güç Faktörü** >0.95  
**Işık Kaynağı** SMD Mid Power LED  
**Kablo** Halojen-Free  
**Giriş Voltajı** 220-240V AC / 50-60 Hz  
**LED Sürücü** Yüksek Verimli Sabit Akım Çıkışlı  
**Ortam Sıcaklığı** -20°C / +50°C  
**LED Ömür L80B50** >50.000 Saat

## OPSİYONEL

- DALI  
- Tunable White  
- CRI > 90  
- Farklı RAL Renk Seçenekleri  
- Class-II Koruma Sınıfı  
- 1-10V DIM  
- Acil Aydınlatma Ünitesi  
- 2700K ~ 6500K  
- Plug-in Connector  
- AC-DC Besleme(MBS)

## MONTAJ

**Montaj Tipi** Sarkıt  
**Montaj Aparatı** Yüksekliği Ayarlanabilir Çelik Tel

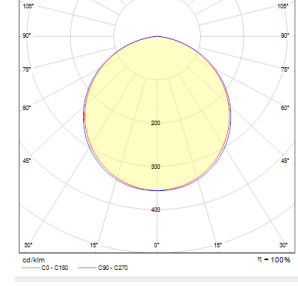
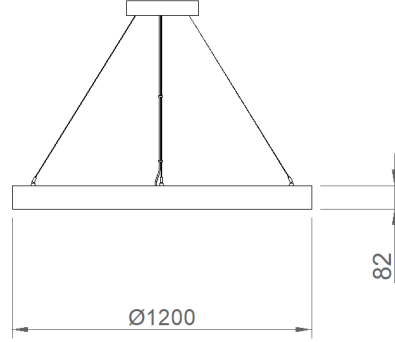
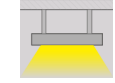

Sipariş Kodu	W	Lm	CCT	CRI	ØxH (mm)	Kg
01140.12.30.102	120	10270	3000	Ra>80	Ø1200x82	6,0

