

Trigon

Outdoor Lighting - Urban Lighting

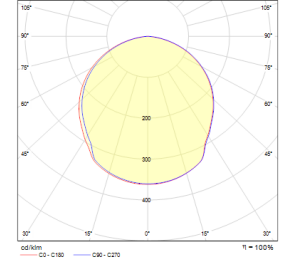
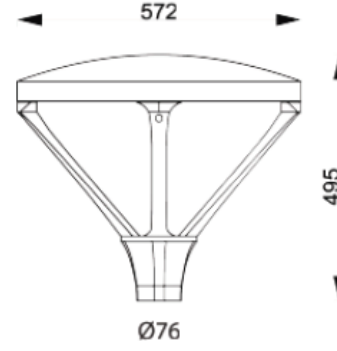
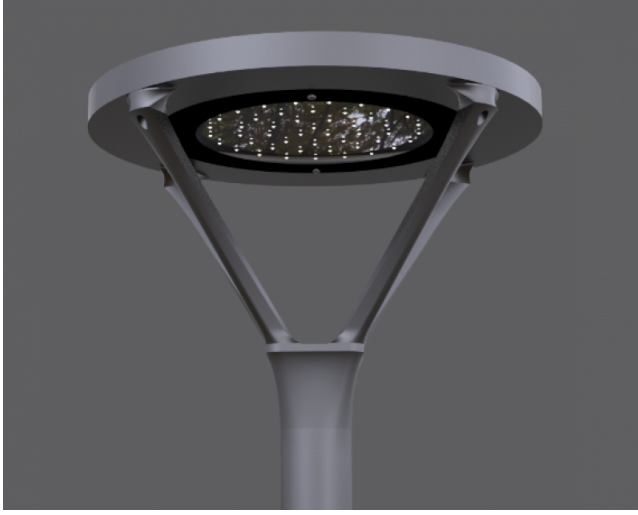

TECHNICAL INFORMATION

Housing	Corrosion Resistant Aluminum
Frame	Aluminum Injection
Glass	Tempered Transparent
Reflector	Optical Lens
Paint	Electrostatic Powder Paint

OPTICAL SPECIFICATIONS

Optics	Symmetrical
Light Output Angle	120°
UGR Value	UGR ≤ 25
CRI	CRI ≥ 80
Color Bin Value	Mc Adams ≤ 3

ELECTRICAL

Power (W)	40-90W
Power Factor	>0.95
Light Source	High Power LED
Cabling	Halogen-Free
Input Voltage	220-240V AC / 50-60 Hz
LED Driver	High Efficiency Constant Current Output
Ambient Temperature	-30°C / +60°C
LED Lifetime L80B50	>50.000 Hour

OPTIONAL

- DALI	- 1-10V DIM
- Tunable White	- Emergency Lighting Unit
- 2700K ~ 6500K	- CRI > 90
- Different RAL Color Options	- Plug-in Connector
- Class-I Protection Class	- AC-DC Supply(MBS)

ASSEMBLY

Order Code	W	Lm	CCT	CRI	L (mm)
09493.56.60.145	90	13890	6000	Ra>70	6000

