

Angel 600

Indoor Lighting - Pendant Lighting



Colour Options



Ral 9016



Ral 9006



Ral 9005

TECHNICAL INFORMATION

Housing	Extruded Aluminum Profile
Diffuser	Highly Transmissive Opal Diffuser
Paint	Electrostatic Powder Paint

OPTICAL SPECIFICATIONS

Optics	Symmetrical
Light Output Angle	120°
UGR Value	UGR < 22
CRI	CRI > 80
Color Bin Value	Mc Adams < 3

ELECTRICAL

Power (W)	40-60W
Power Factor	>0.95
Light Source	SMD Mid Power LED
Cabling	Halogen-Free
Input Voltage	220-240V AC / 50-60 Hz
LED Driver	High Efficiency Constant Current Output
Ambient Temperature	-20°C / +50°C
LED Lifetime L80B50	50.000 Hour

OPTIONAL

- DALI	- 1-10V DIM
- Tunable White	- Emergency Lighting Unit
- CRI > 90	- 2700K ~ 6500K
- Different RAL Color Options	- Plug-in Connector
- Class-II Protection Class	- AC-DC Supply(MBS)

ASSEMBLY

Installation Type	Pendant
Mounting Apparatus	Height Adjustable Steel Wire

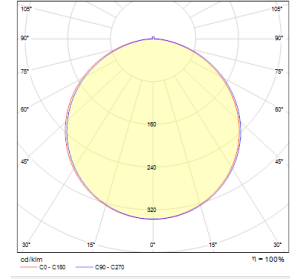
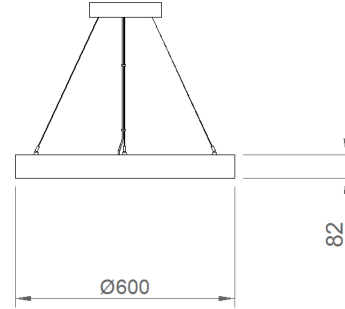

Order Code	W	Lm	CCT	CRI	ØxH (mm)	Kg
01140.60.40.054	60	5040	4000	Ra>80	Ø600x82	3,0

