

Getto

Indoor Lighting - Industrial Lighting



Colour Options



Ral 7016

TECHNICAL INFORMATION

Housing	Aluminum Injection
Reflector	Clear optic lens
Paint	Electrostatic Powder Paint

OPTICAL SPECIFICATIONS

Optics	Symmetrical
Light Output Angle	60°, -90°, -120°
UGR Value	UGR ≤ 22
CRI	CRI ≥ 80
Color Bin Value	Mc Adams ≤ 3

ELECTRICAL

Power (W)	60-160W
Power Factor	>0.95
Light Source	SMD Mid Power LED
Cabling	Halogen-Free
Input Voltage	220-240V AC / 50-60 Hz
LED Driver	High Efficiency Constant Current Output
Ambient Temperature	-20°C / +50°C
LED Lifetime L80B50	>50.000 Hour

OPTIONAL

- DALI	- 1-10V DIM
- Emergency Lighting Unit	- CRI > 90
- 2700K ~ 6500K	- Different RAL Color Options
- Plug-in Connector	- Class-I Protection Class
- PIR Sensor	- AC-DC Supply(MBS)

ASSEMBLY

Installation Type	Surface Mounted
Mounting Apparatus	Metal Bracket

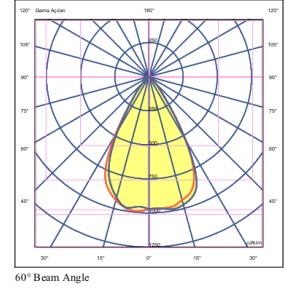
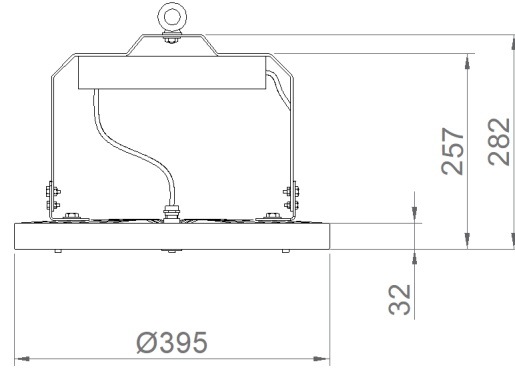
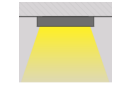

Order Code	W	Lm	Lm	CRI	Kg
07306.39.40.190	160	22240	4000	Ra>80	4,2

