

Owl

Indoor Lighting - Spot Lighting



Colour Options



TECHNICAL INFORMATION

Housing	Aluminum Injection
Frame	Aluminum Injection
Reflector	Metallized Surface Optical Reflector + Glass
Paint	Electrostatic Powder Paint

OPTICAL SPECIFICATIONS

Optics	Symmetrical
Light Output Angle	50°
UGR Value	UGR ≤ 20
CRI	CRI ≥ 80
Color Bin Value	Mc Adams ≤ 3

ELECTRICAL

Power (W)	30W
Power Factor	>0.95
Light Source	COB LED
Cabling	Halojen-Free
Input Voltage	220-240V AC / 50-60 Hz
LED Driver	High Efficiency Constant Current Output
Ambient Temperature	-20°C / +50°C
LED Lifetime L80B50	>50.000 Hour

OPTIONAL

- DALI	- 1-10V DIM
- Tunable White	- Emergency Lighting Unit
- CRI > 90	- 2700K ~ 6500K
- Different RAL Color Options	- Plug-in Energy Input Connector
- Class-I Protection Class	- AC-DC Supply(MBS)

ASSEMBLY

Installation Type	Under Plaster
Mounting Apparatus	Steel Spring

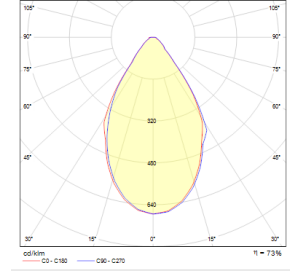
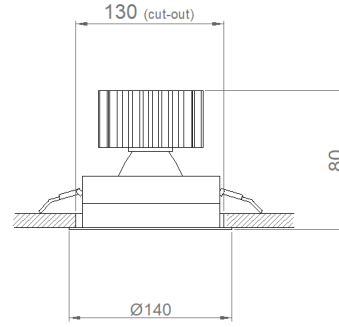

Order Code	W	Lm	CCT	CRI	ØxH (mm)	Ceiling Cutting (mm)
05379.14.40.027	30	2700	4000	Ra>80	140x110	Ø130

